

## FOLDING OPERABLE SHUTTER

## INSTALLATIONS INSTRUCTION

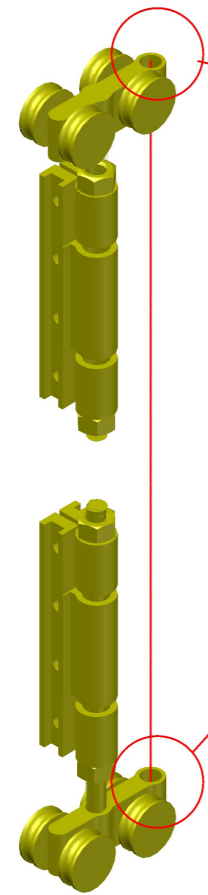

1. Slide the "Lifting wheel hinge" and "Lower pull hinge" from the side of the track.



Note:  
Ensure alignment between holes.

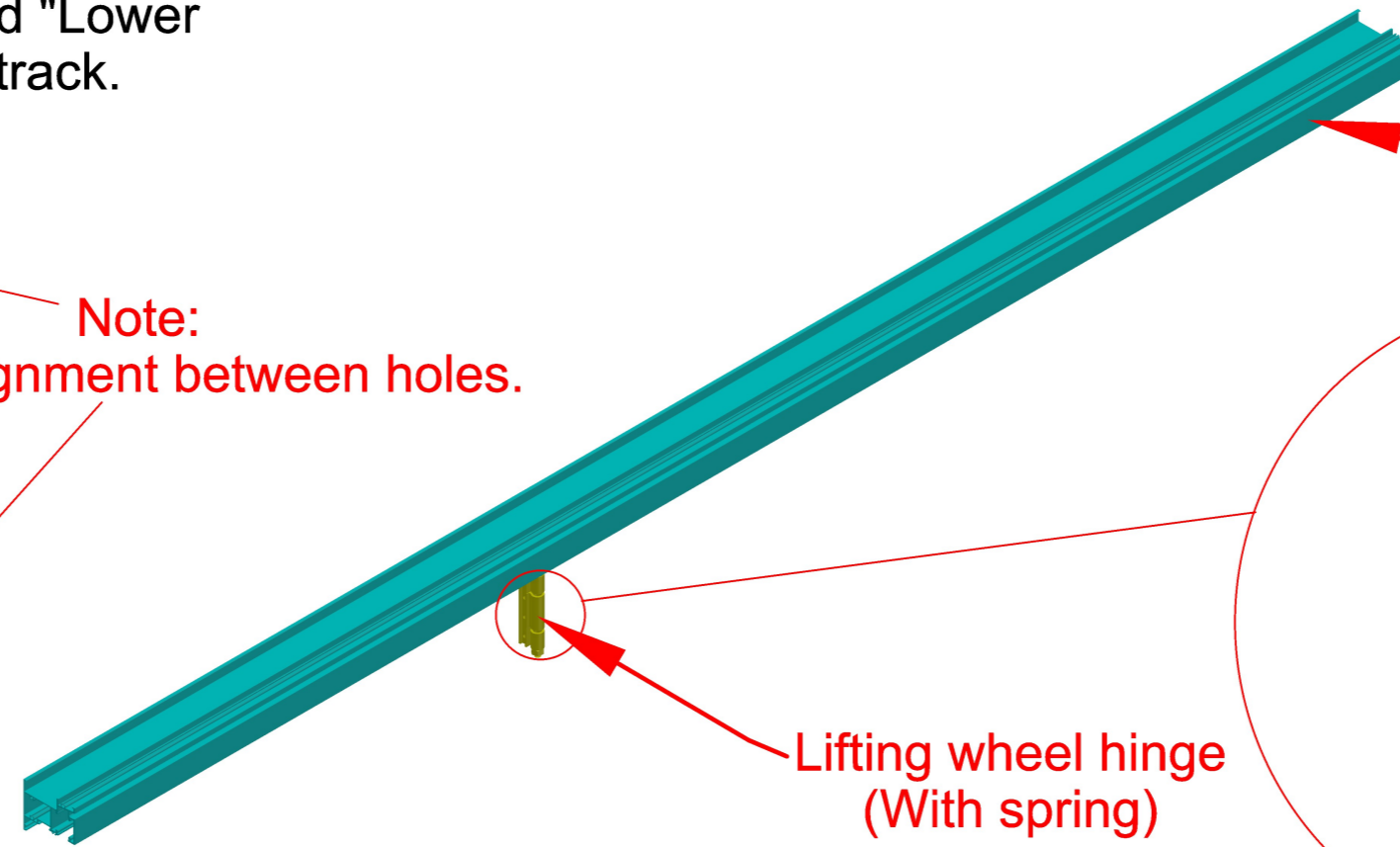

Top Rail

Lifting wheel hinge  
(With spring)

Note:  
1. Please pay attention to the inner and  
outer orientation of the track.

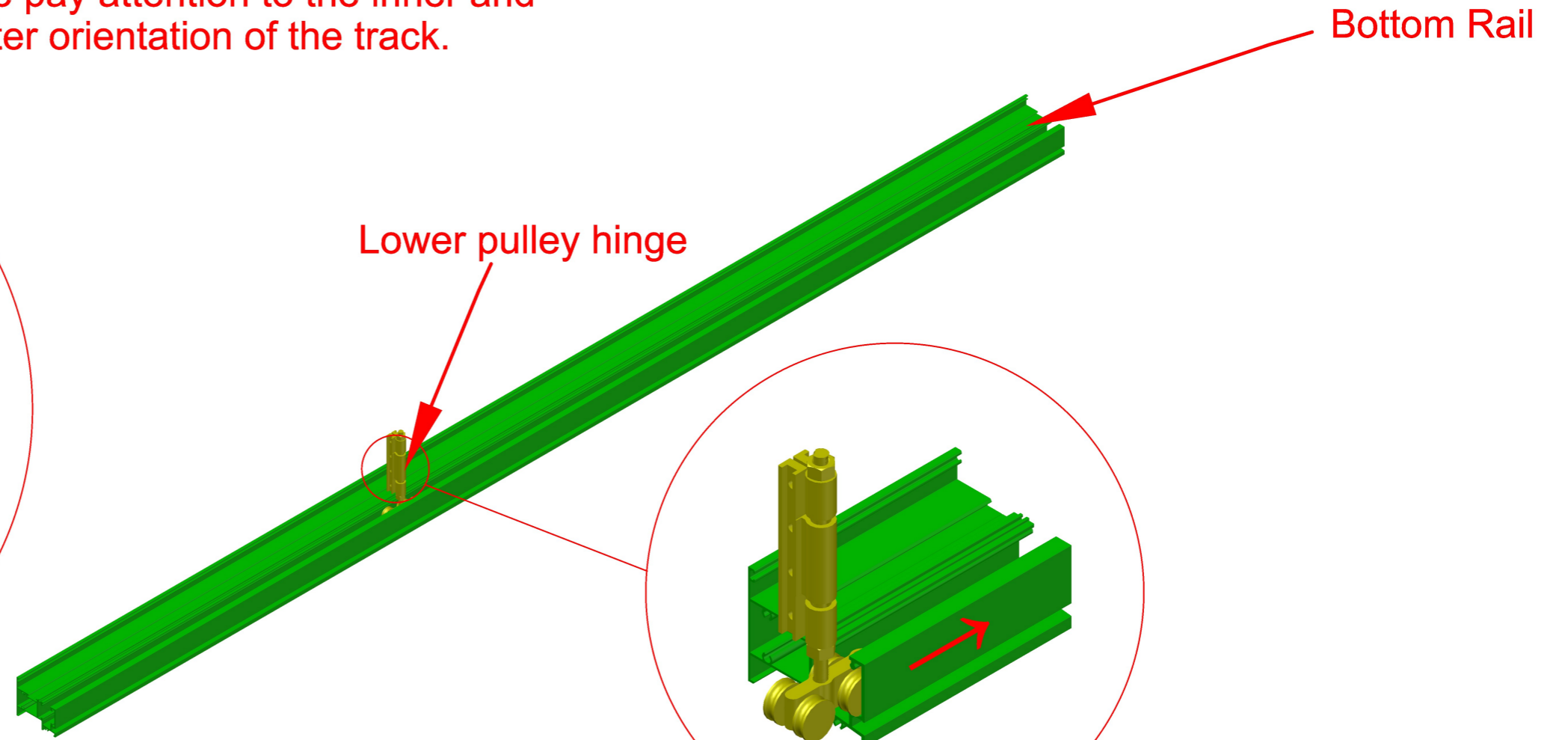
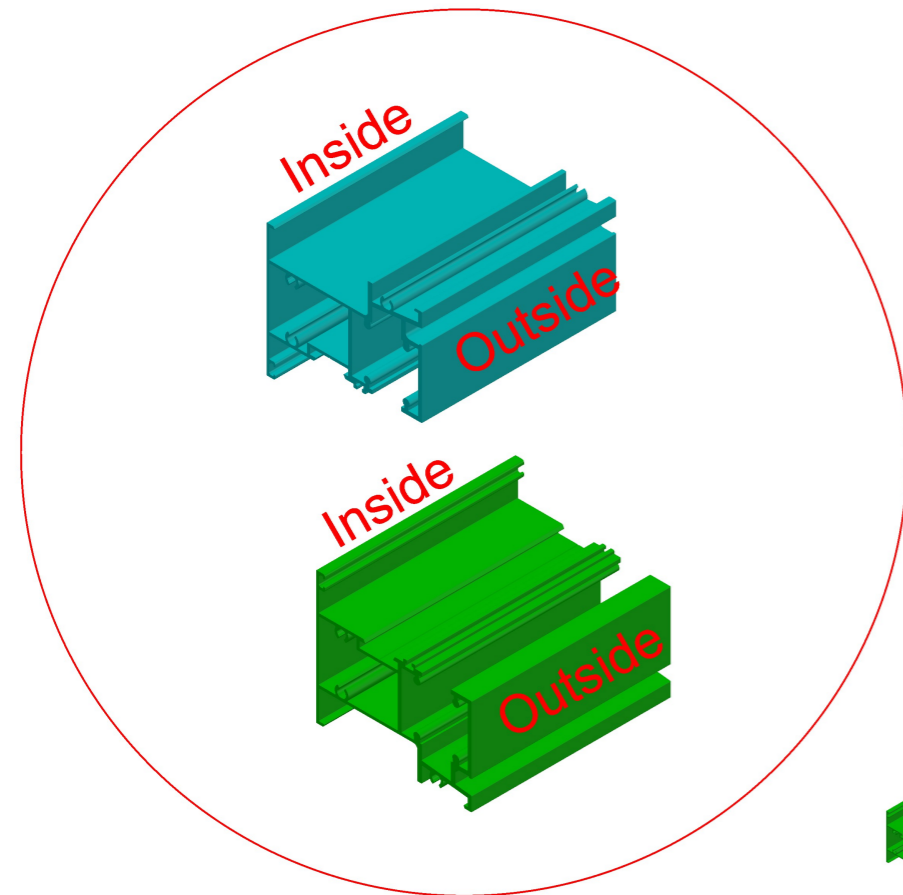

Bottom Rail

Lower pulley hinge

2. Use screws assembly the top rail and bottom track and side frame to be a structure.

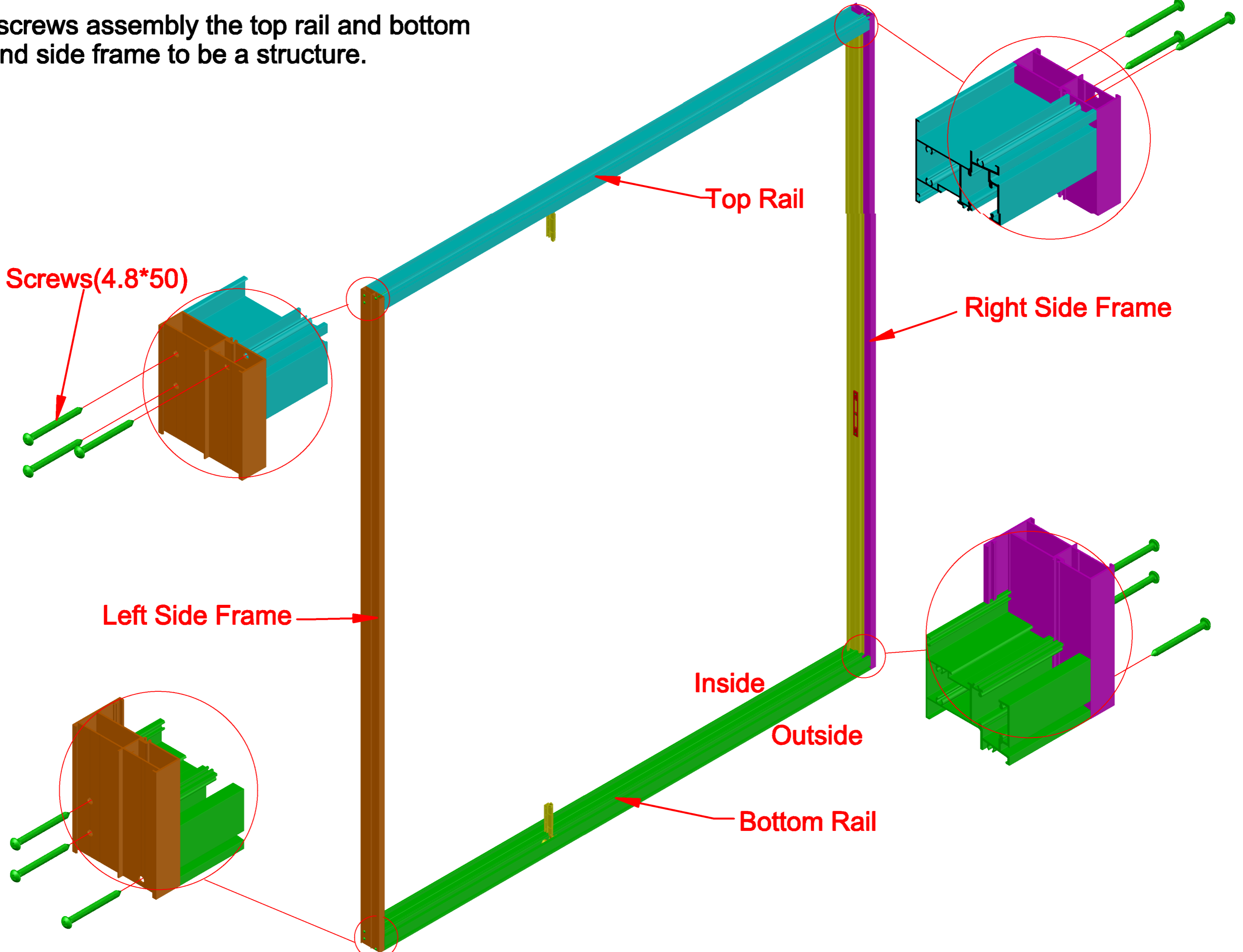

3.As shown, the width between two side frame and diagonal should be measured and leveled. This is to ensure that the inner dimensions for installing the Folding Door is accurate.

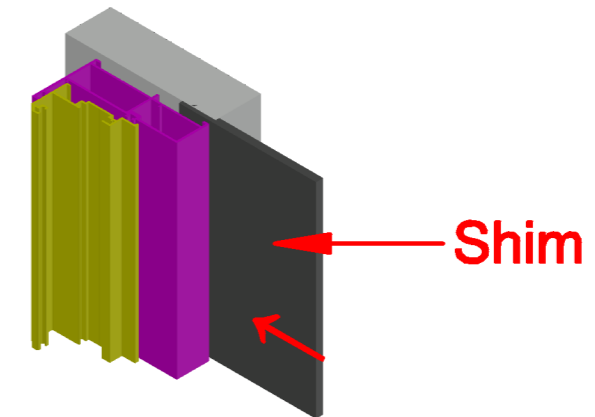
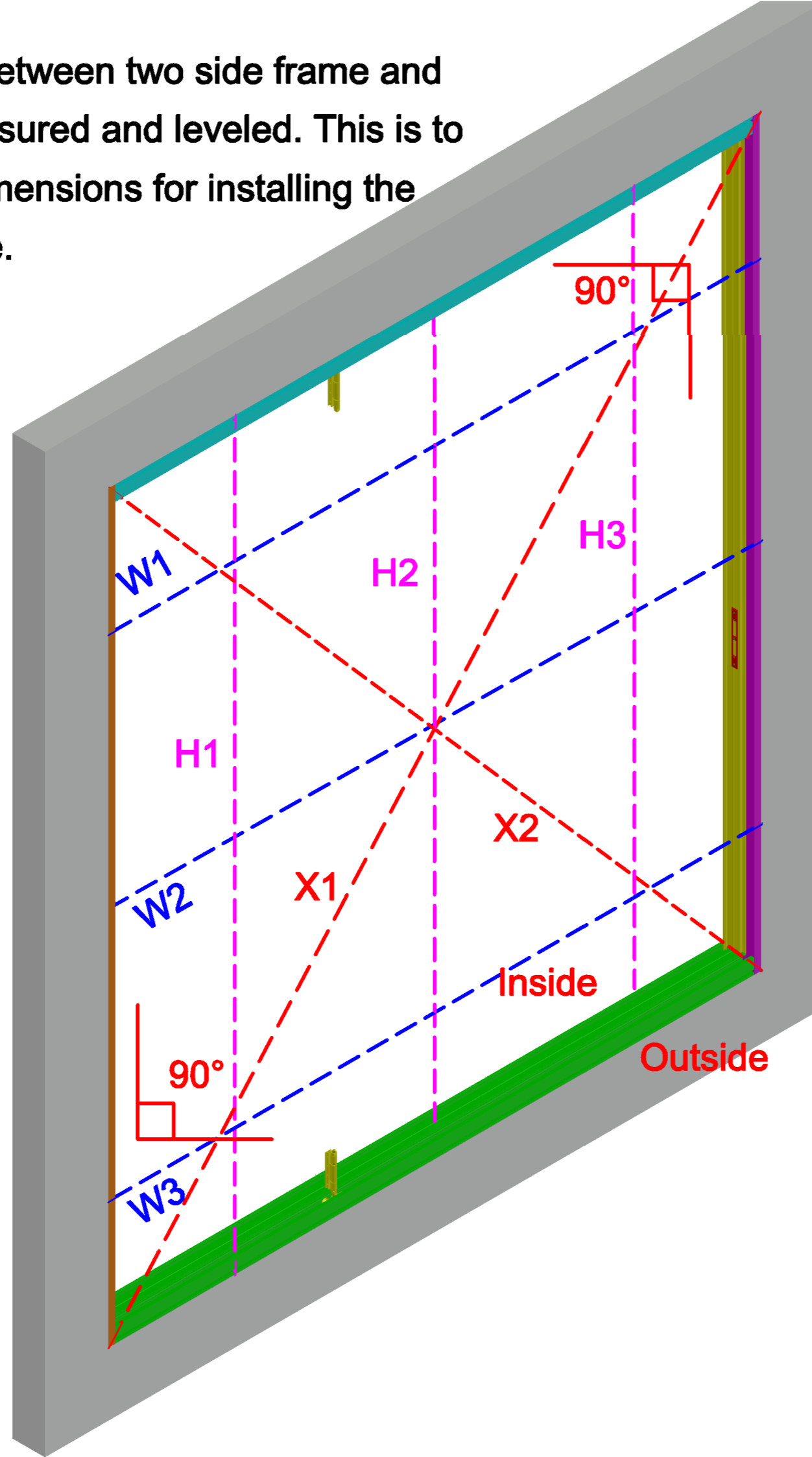

If there is still a gap after adjustment, it can be leveled by adding shims or other pads. Please fix the shim according to the site(not provided).

Note:

The Folding Door installed inside any type of opening sidewall, it must adjust the size of opening to make sure ( $W1=W2=W3$ ;  $X1=X2$ ,  $H1=H2=H3$ ) all equal and fit.

If not, it will affect the Folding Door movement. It is best to adjust with a level gauge.

4. Use screws to fix the whole framework.

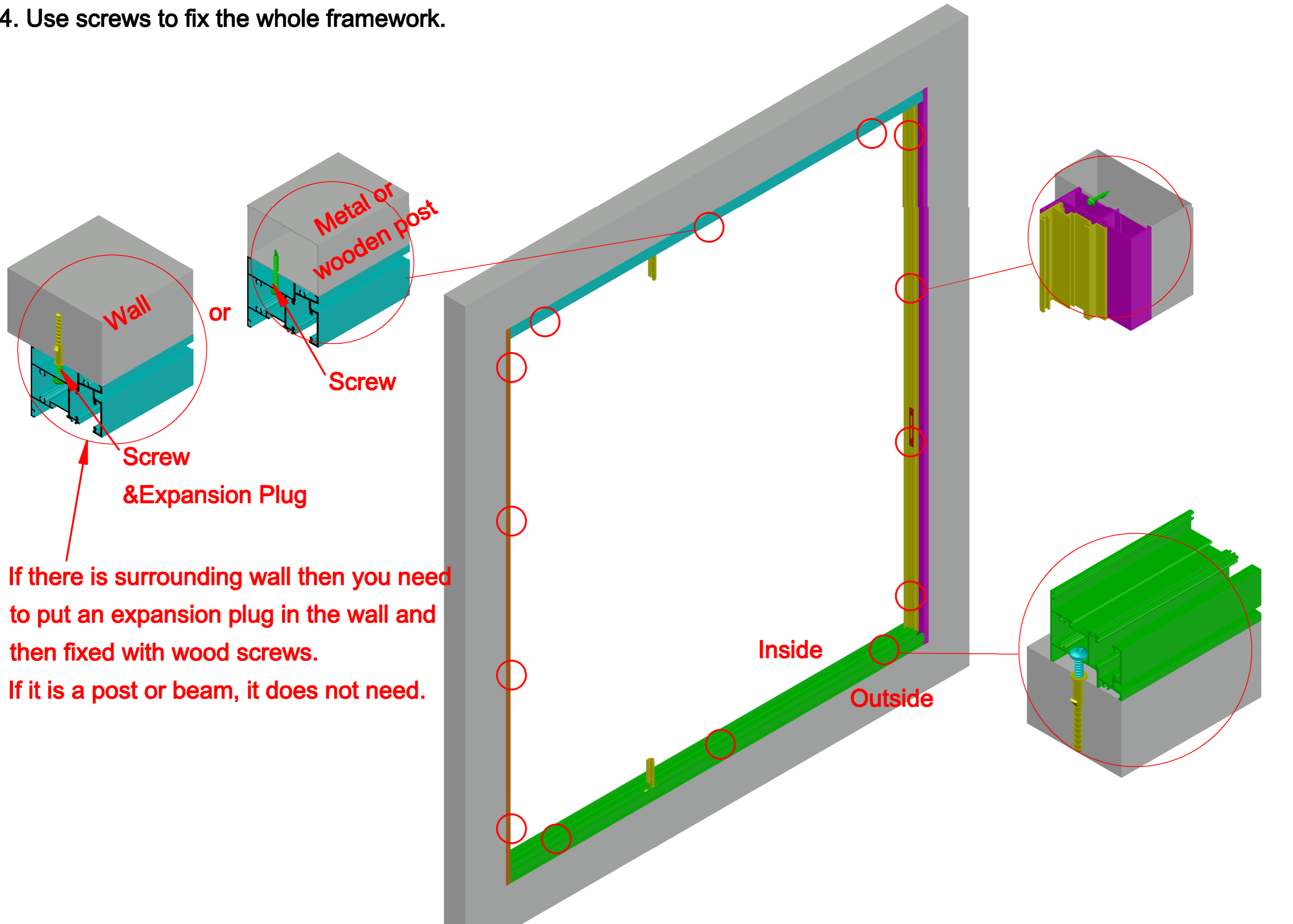

If there is surrounding wall then you need to put an expansion plug in the wall and then fixed with wood screws.  
If it is a post or beam, it does not need.

5. Fix "Left Side Frame" and "1st Panel On The Left" together.

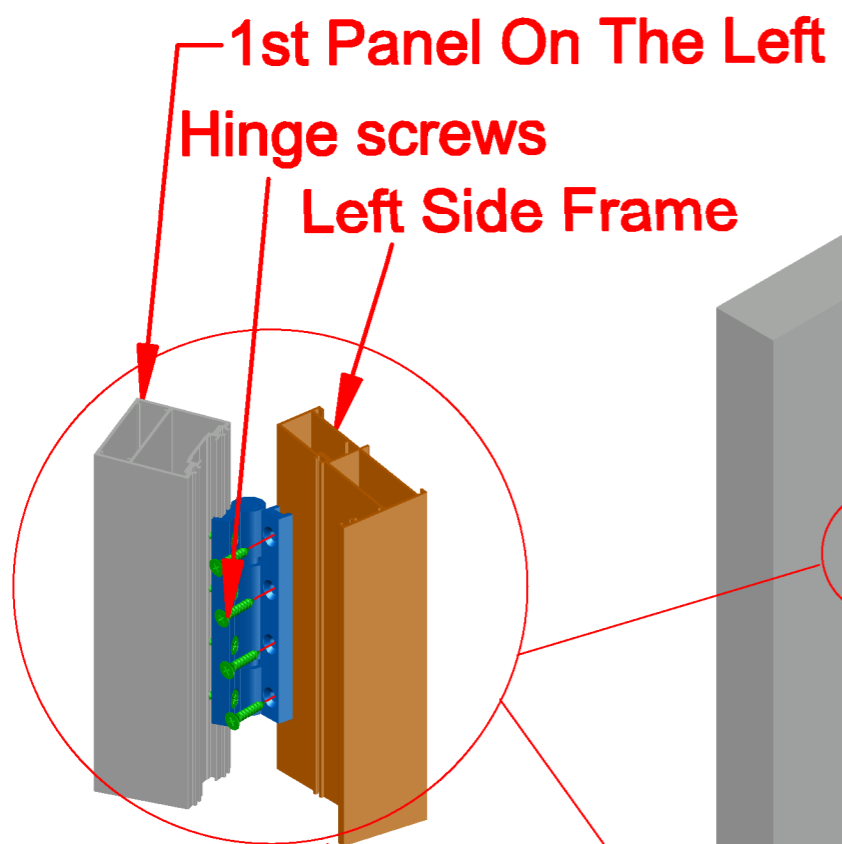

**Note:**  
This is the perspective inside

**Note:**  
1. Please note the inside and outside of "1st Panel On The Left", and the hinge on the left side is the outside.  
2. "1st Panel On The Left" should be tilted at an appropriate angle to facilitate the installation of hinges.

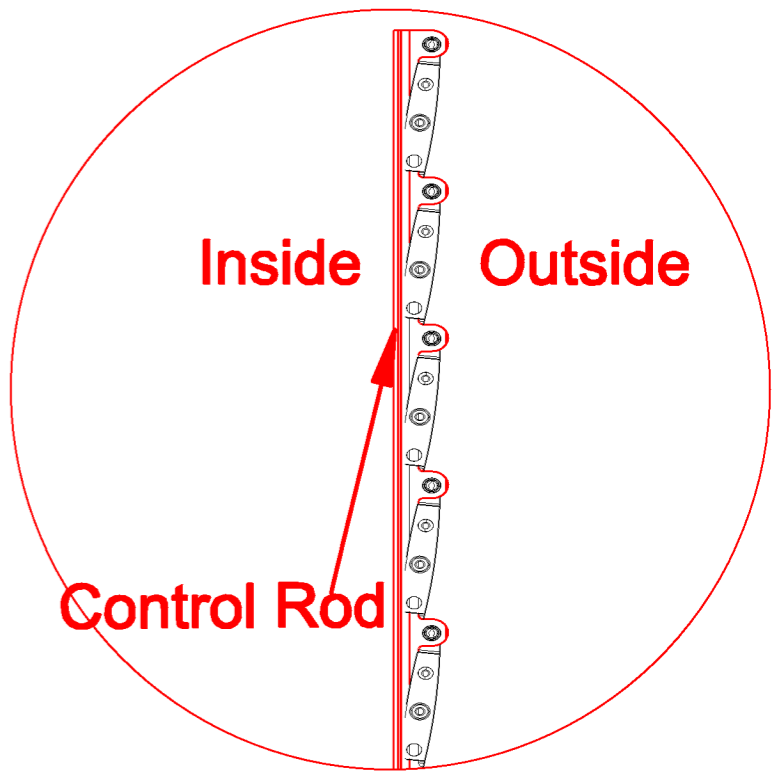
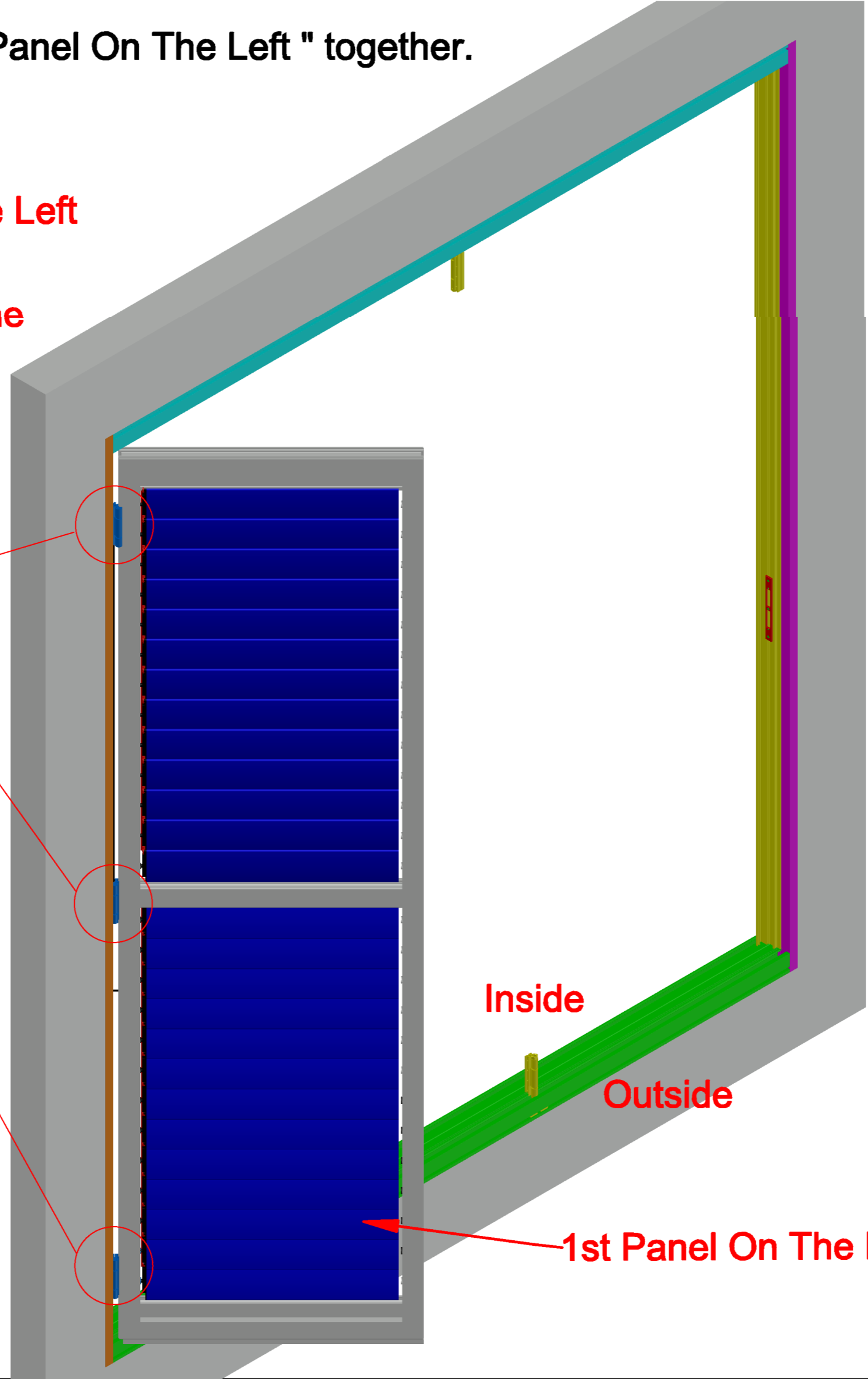

1st Panel On The Left

6. Install "2nd Panel On The Left" in "1st Panel On The Left" and "Lower Pulley hinge&Lifting wheel hinge".

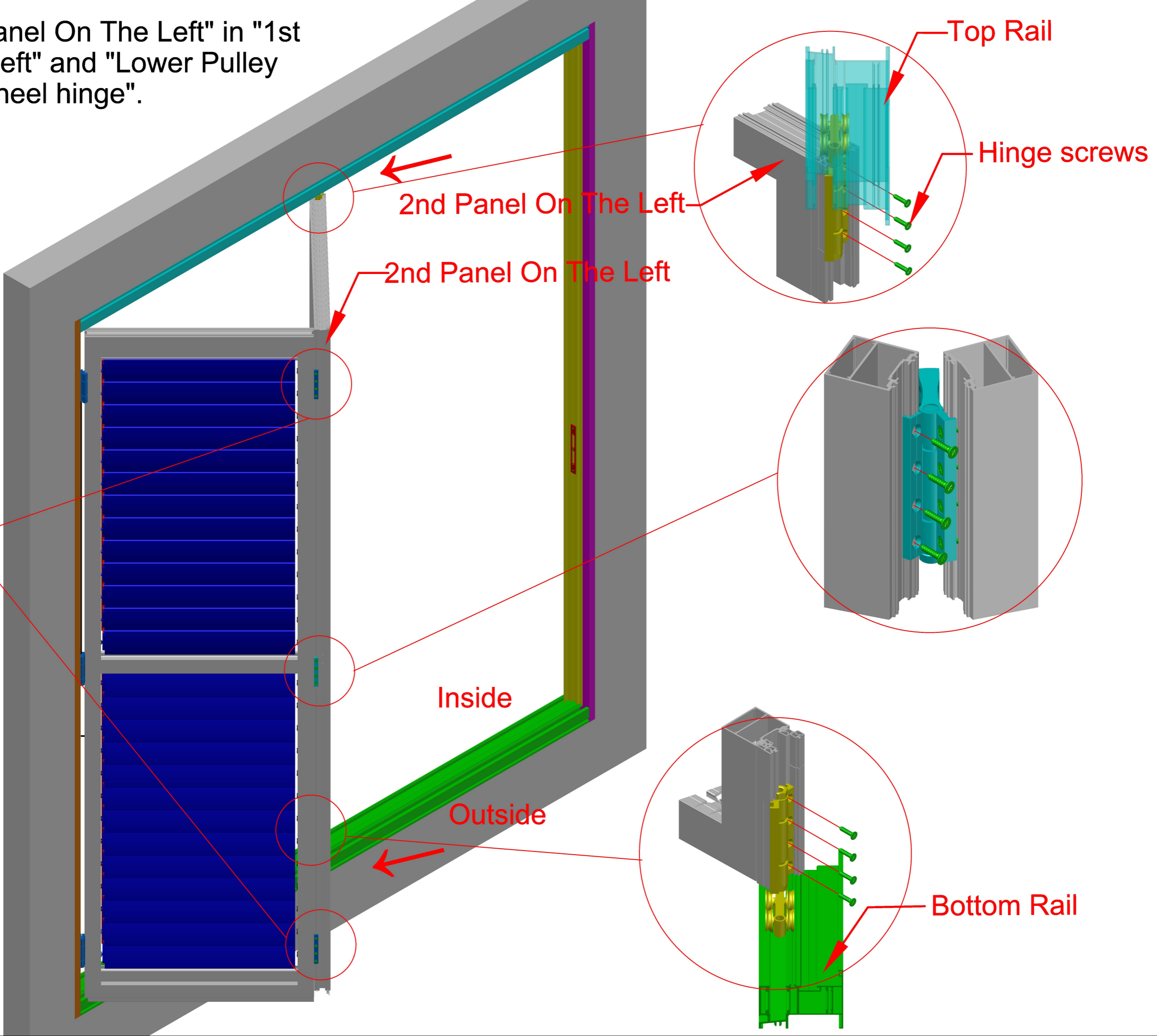

7. Please follow step 6 to connect "2nd Panel On The Left" and "3rd Panel On The Left" together with "Hinge screws".

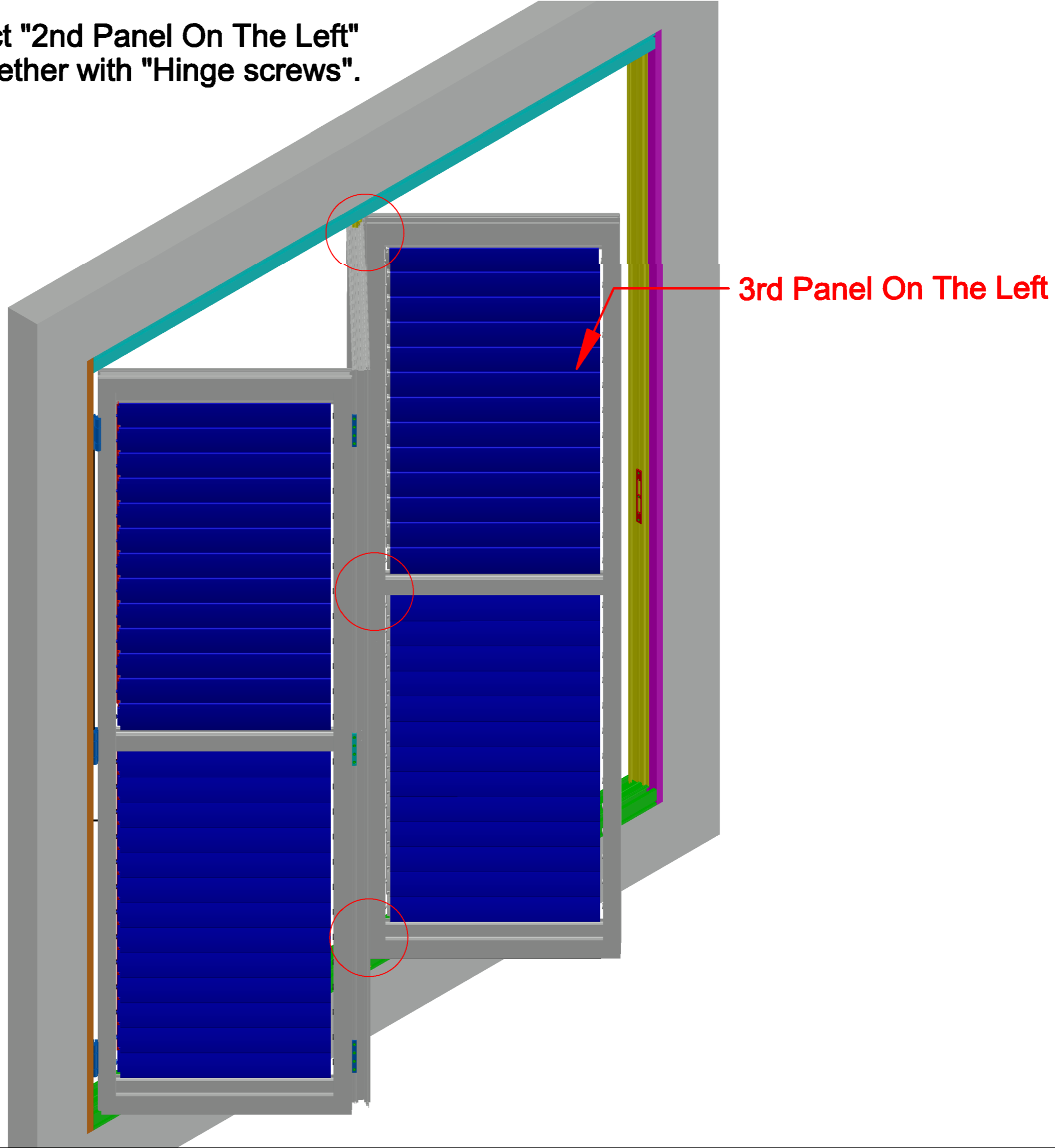

8. Fix "Right Side Frame" and "4th Panel On The Left" together.

1st Panel On The Left

4th Panel On The Left

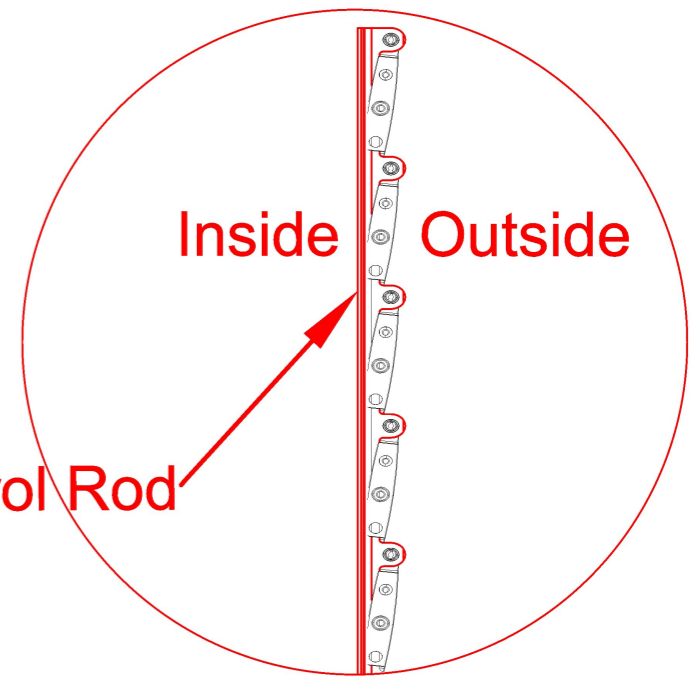
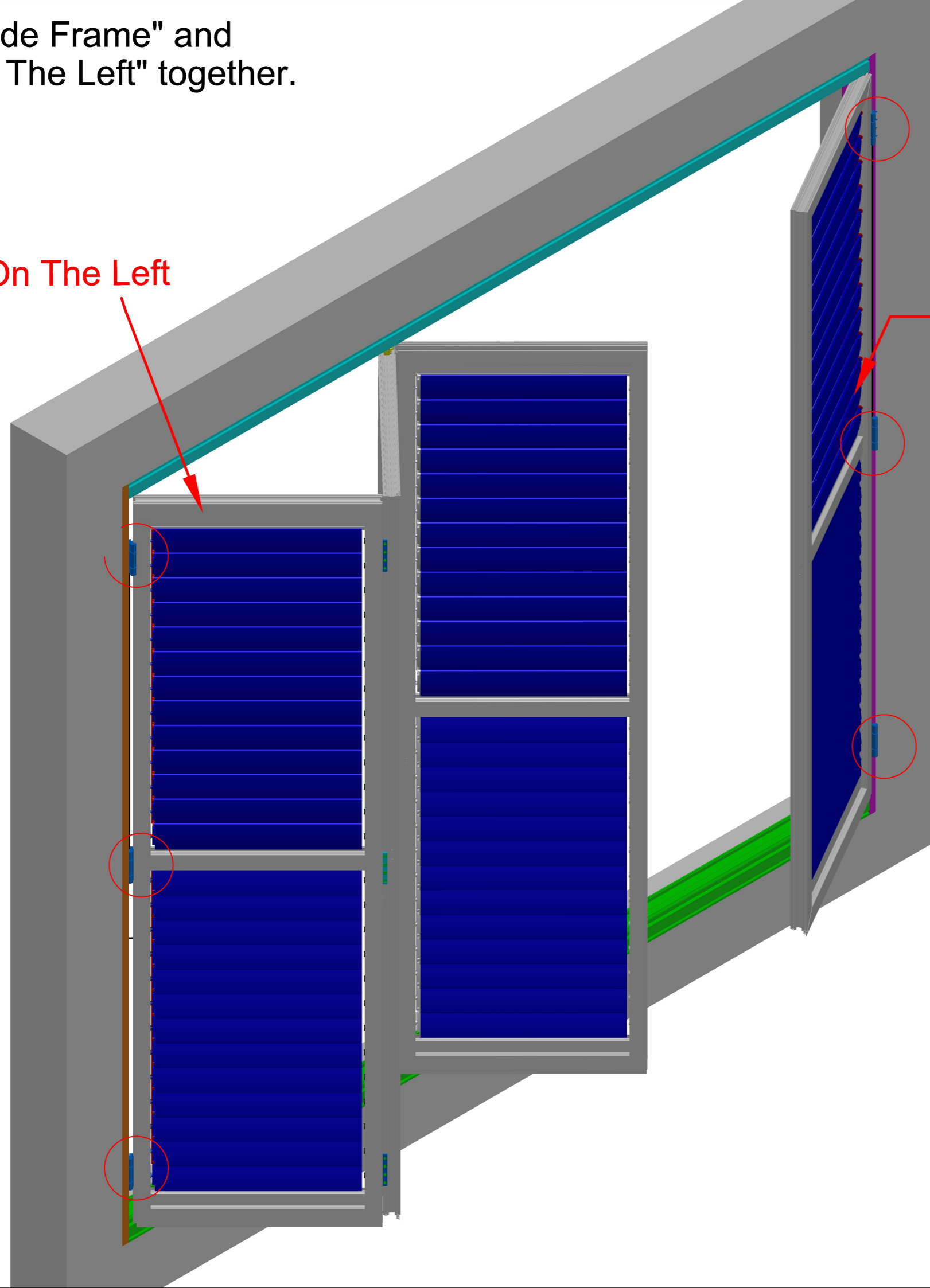

**Note:**  
1. The installation methods for "4th Panel On The Left" and "1st Panel On The Left" are the same, but please note the difference between internal and external.  
2. If there is no "4th Panel On The Left", please ignore this page.

9.As shown,put the frame cover panel into the side frame and fix the Lock cylinder and Lock panel.

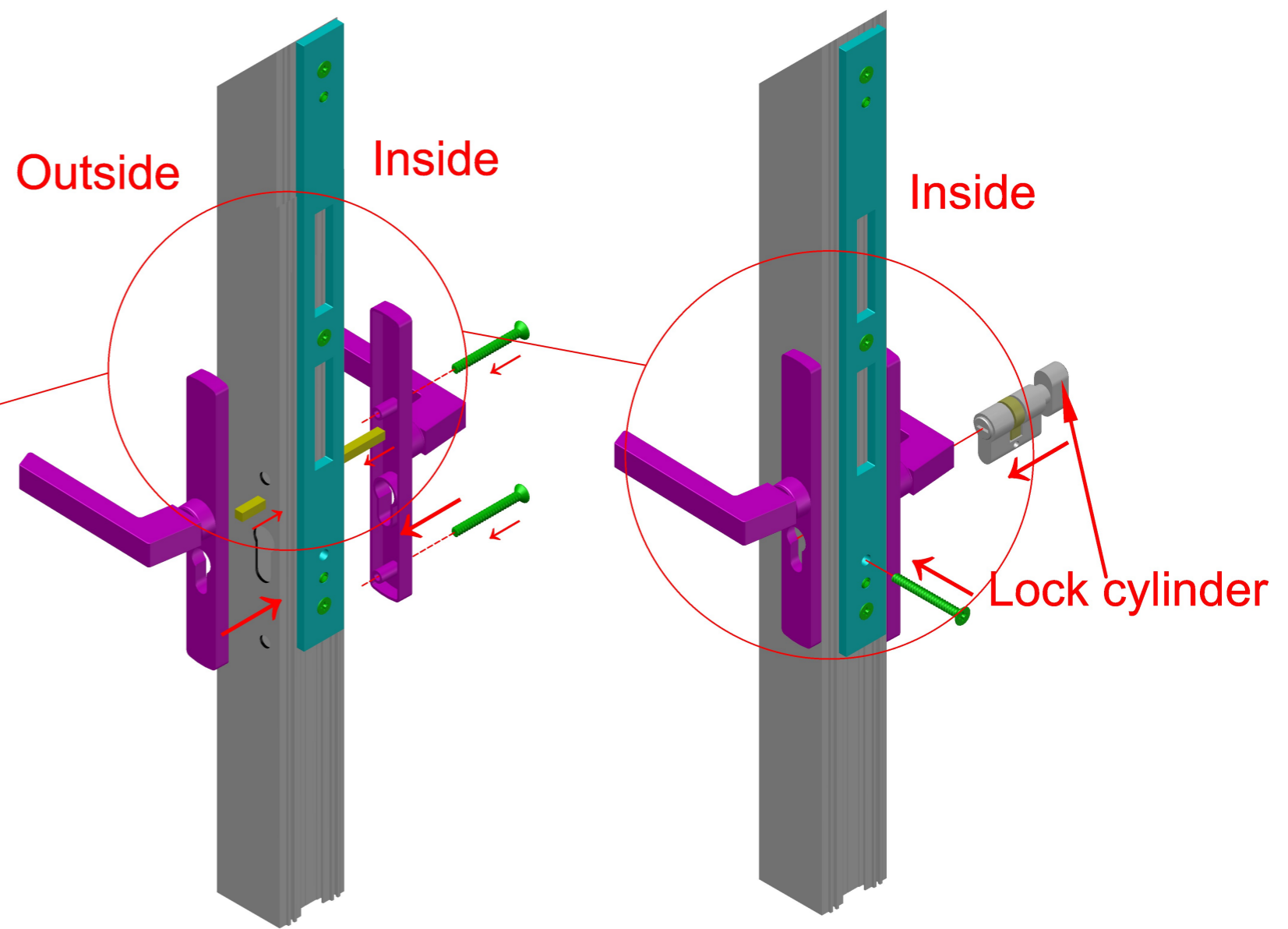
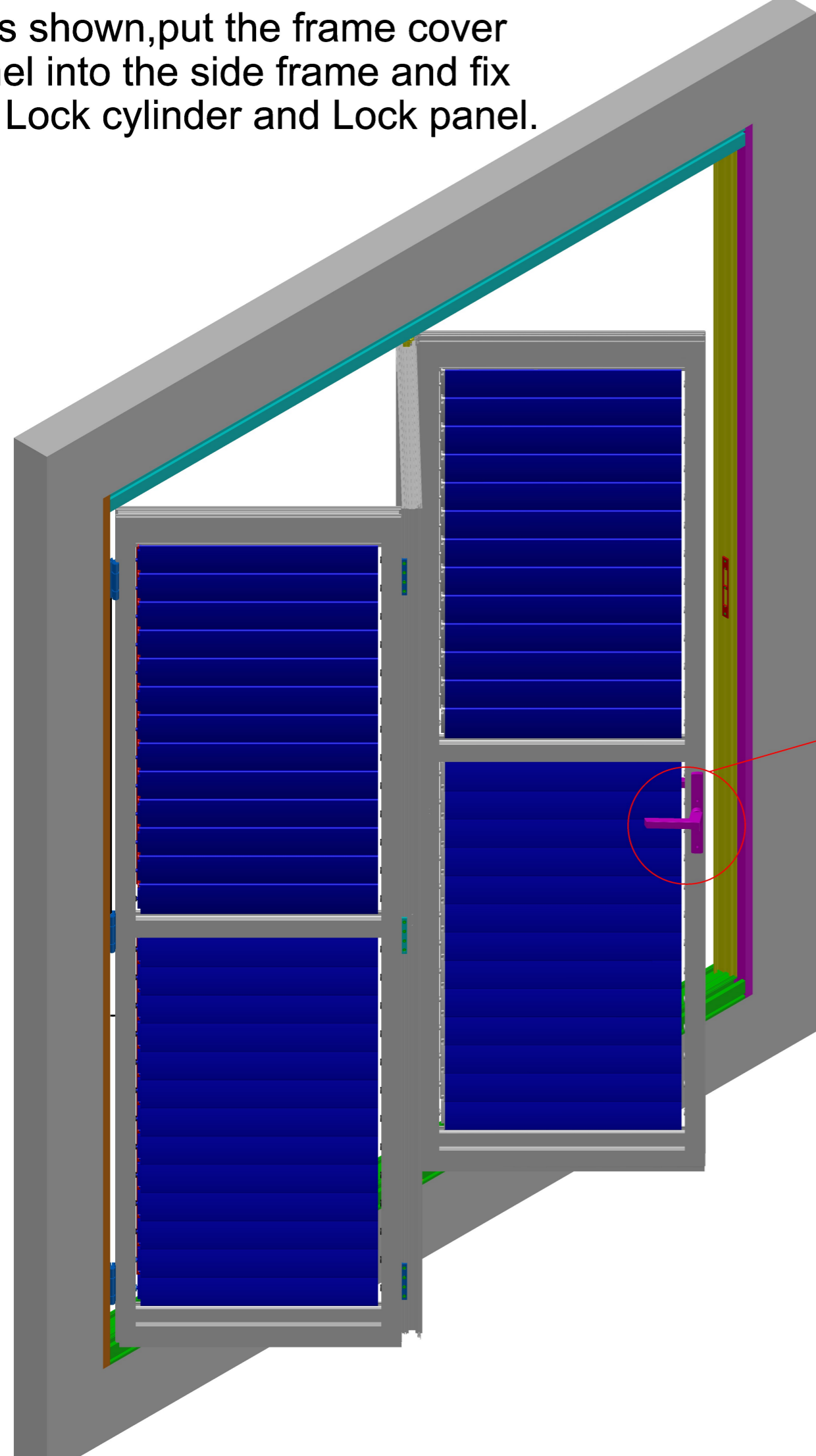

10. Stick the Rubber strip in the circled area.

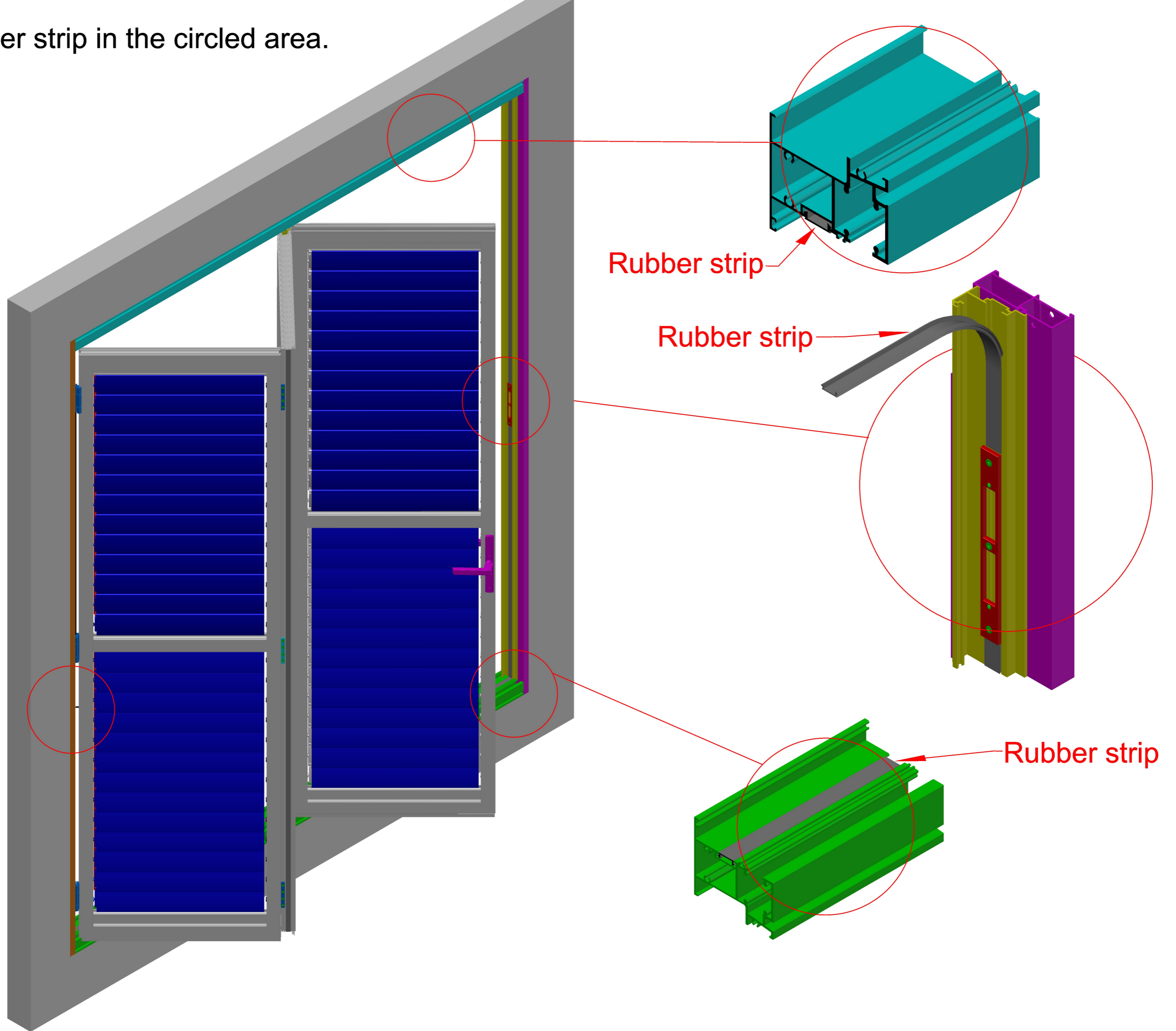

11. Install the "Door clamp" onto the "2nd Panel On The Left" and "3rd Panel On The Left" using screws.

Note:  
Please distinguish the  
difference between two  
"Door clamps".

